

TRIPLE COLUMN LOCKER
4 DOORS LOCKER

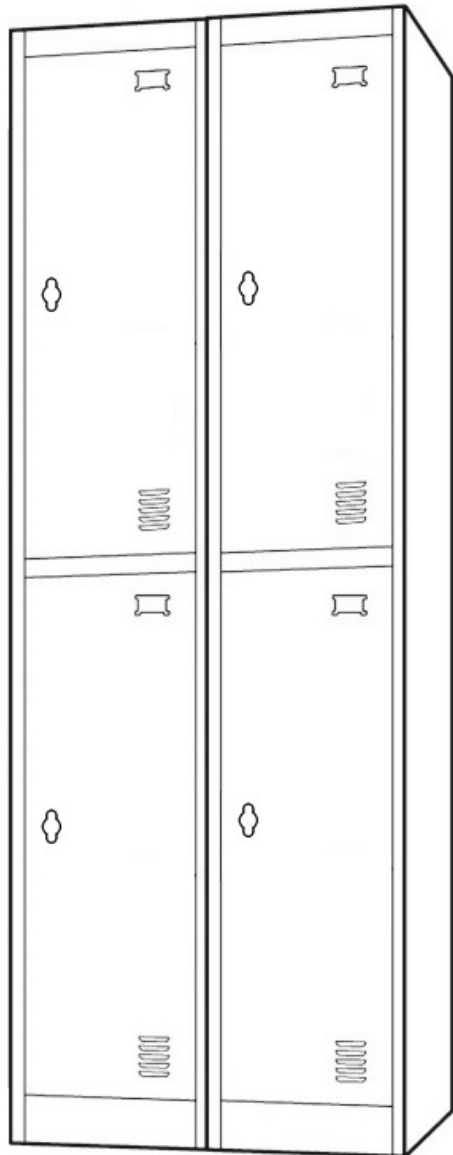

TRIPLE COLUMN LOCKER
6 DOORS LOCKER

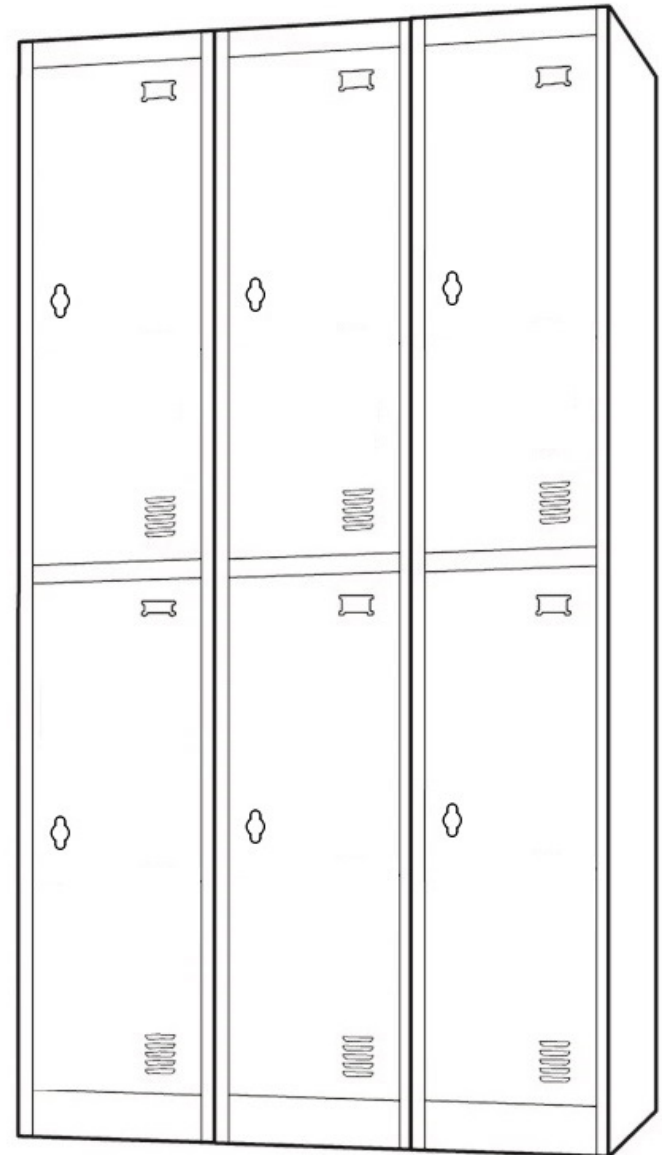



Door A
4 Doors x 2
6 Doors x 3

Back Panel B
4 Doors x 2
6 Doors x 3

Left Side C

Middle Wall D
4 Doors x 1
6 Doors x 2

Right Side E

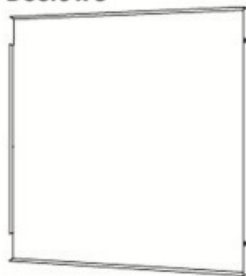

Bottom Panel F
4 Doors x 4
6 Doors x 6



Top Panel G
4 Doors x 2
6 Doors x 3



I

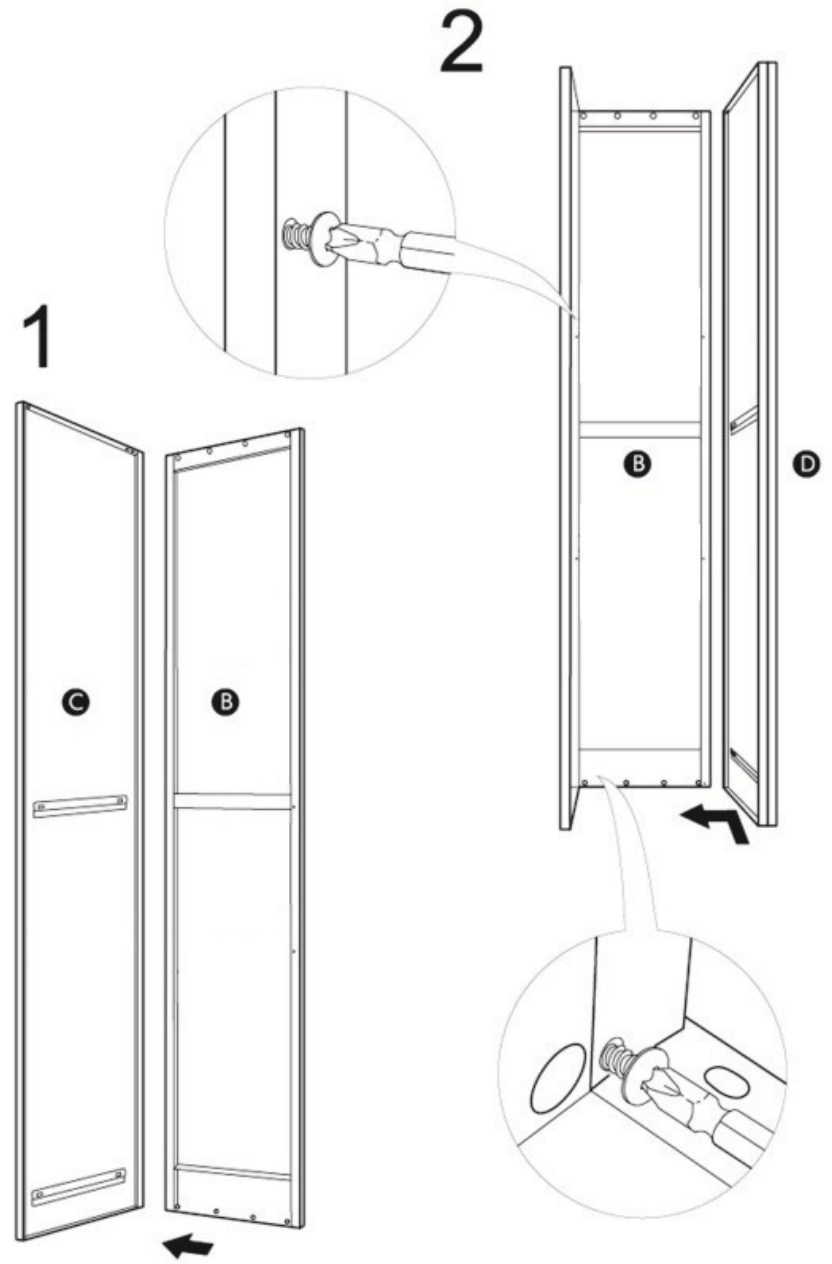

Remark: The Bottom Panel And The Shelves Panels Are Consistent.

3

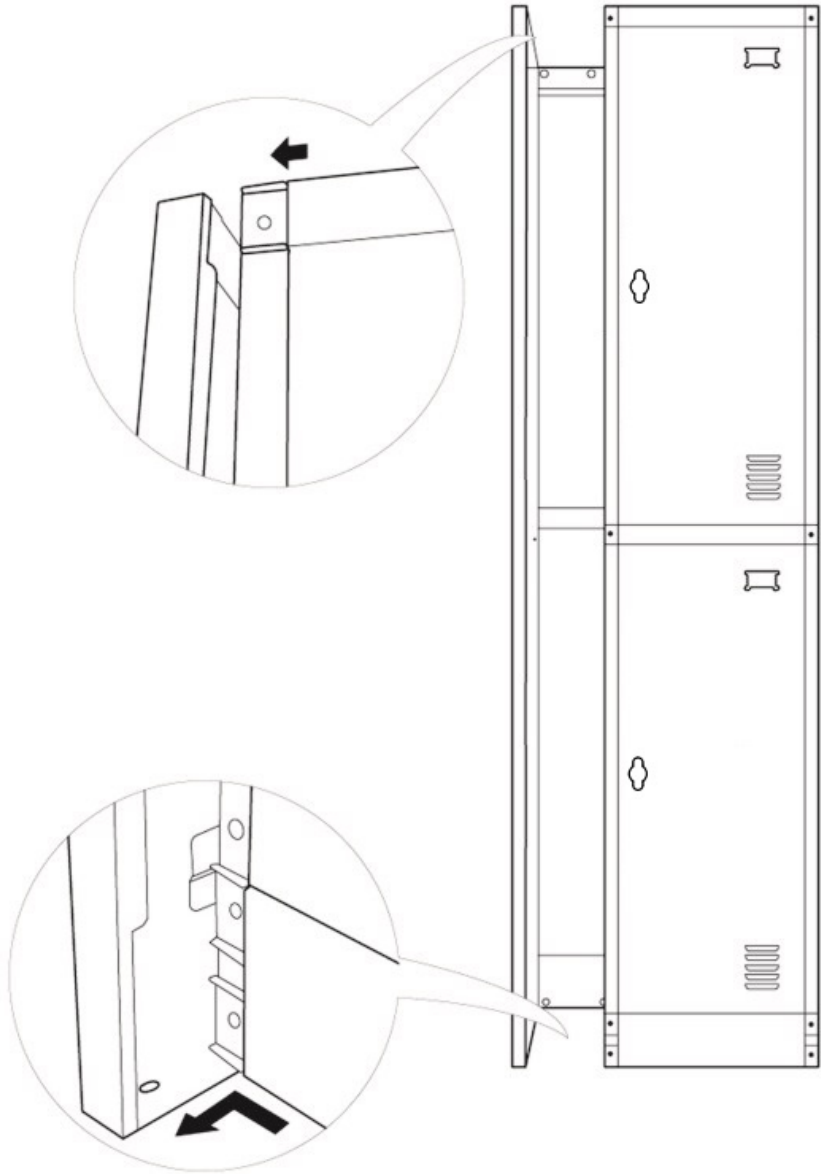

4

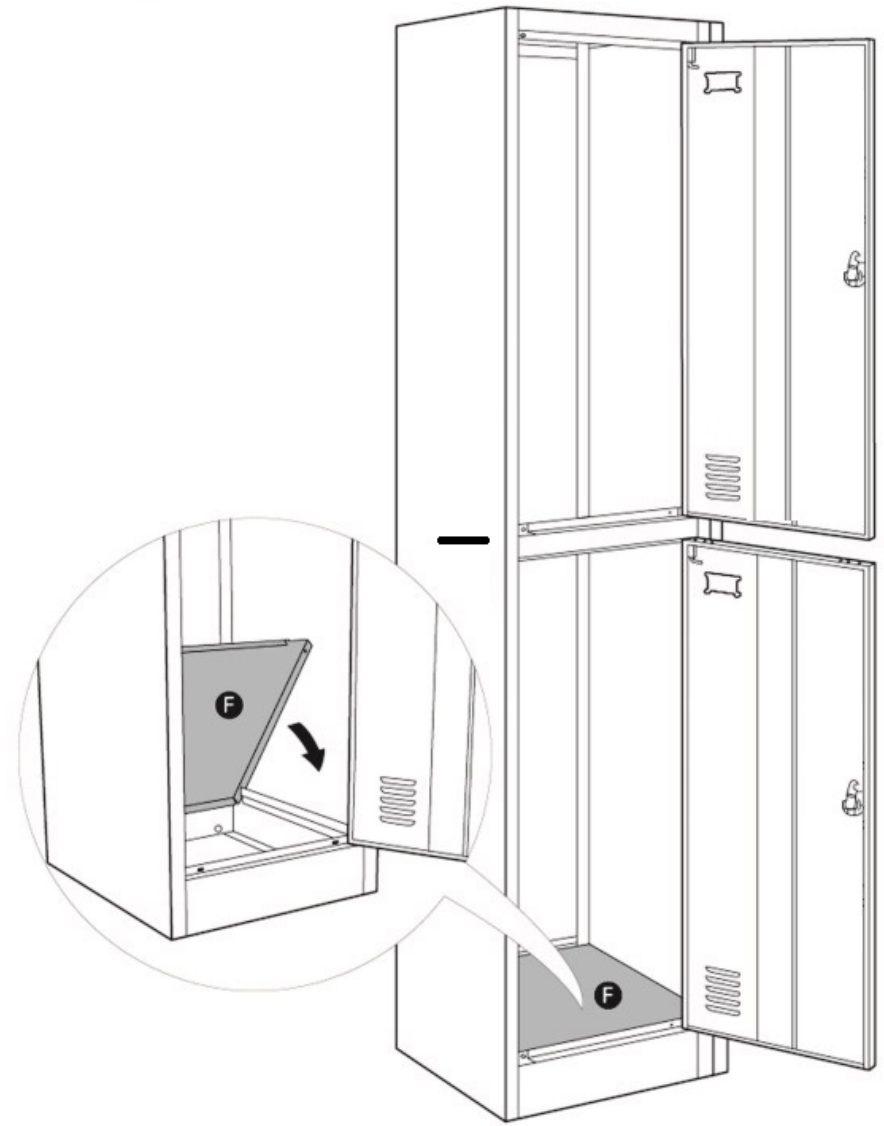

5



6

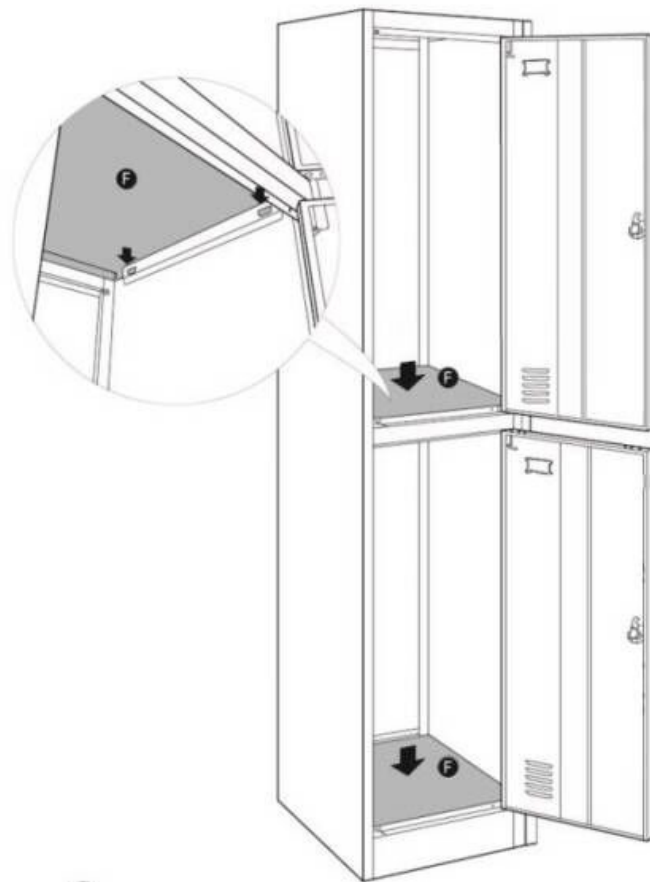

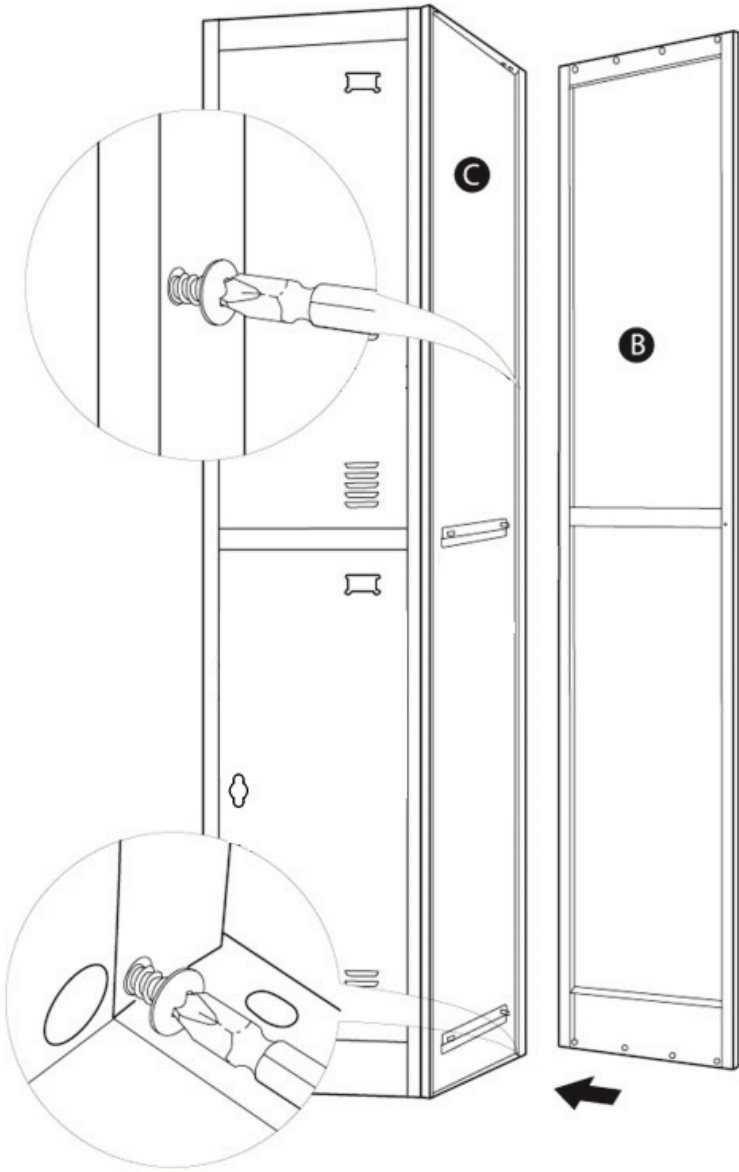

7

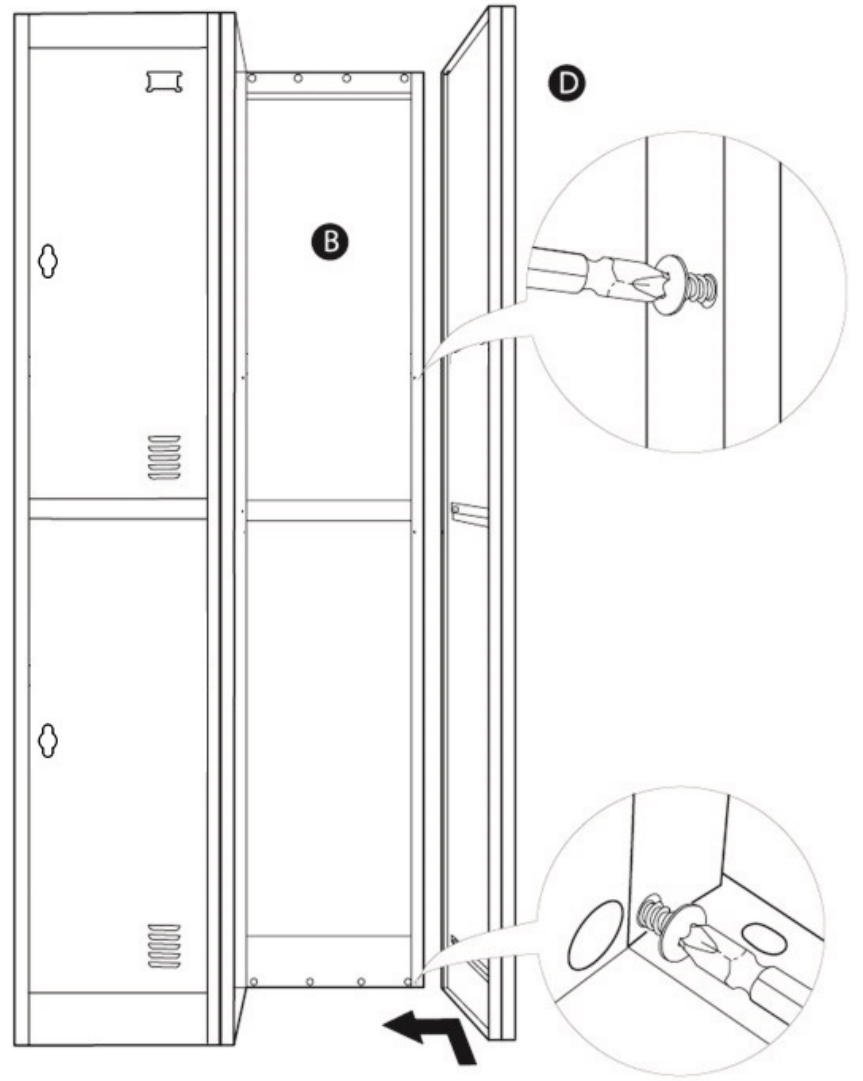

8

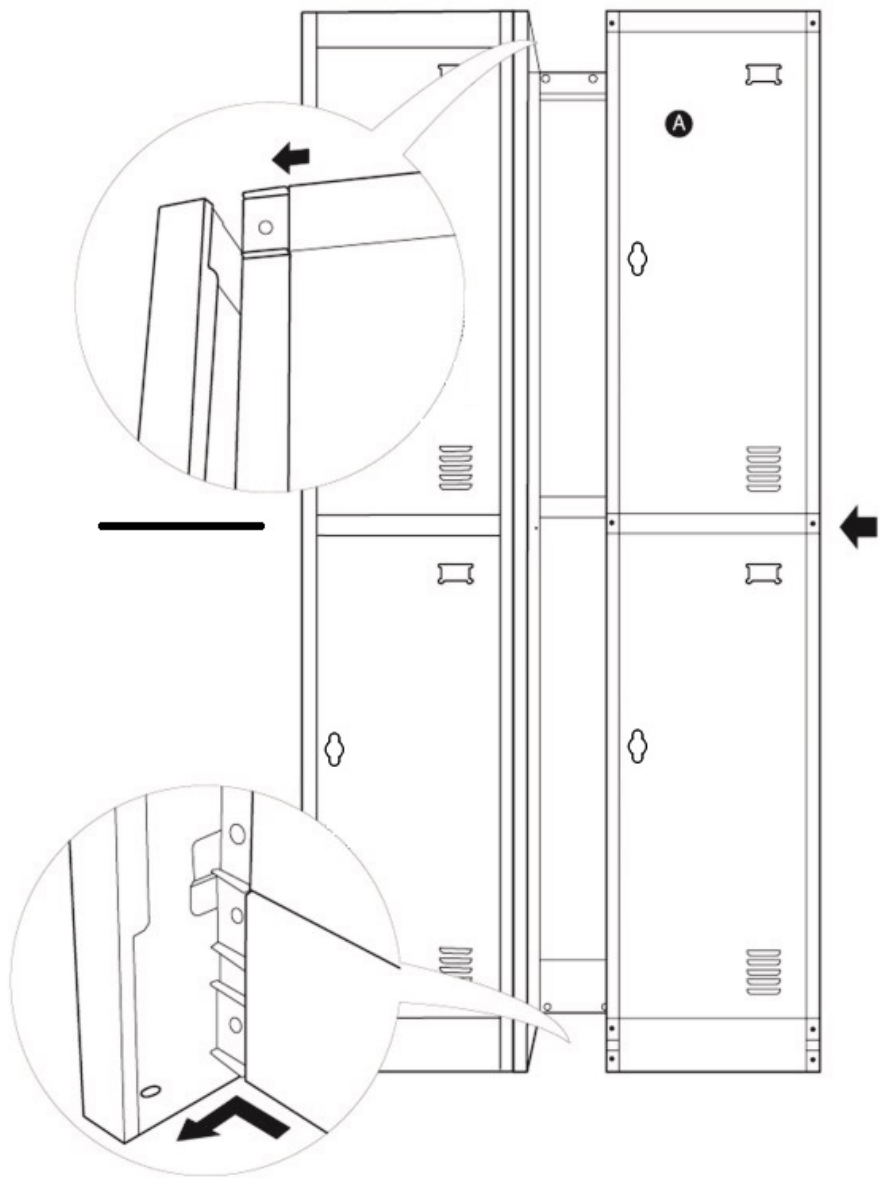

9



10

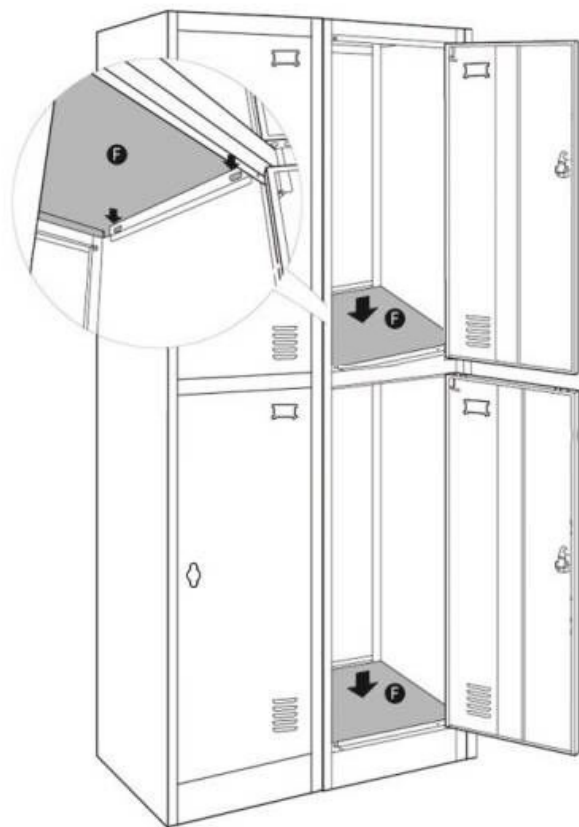
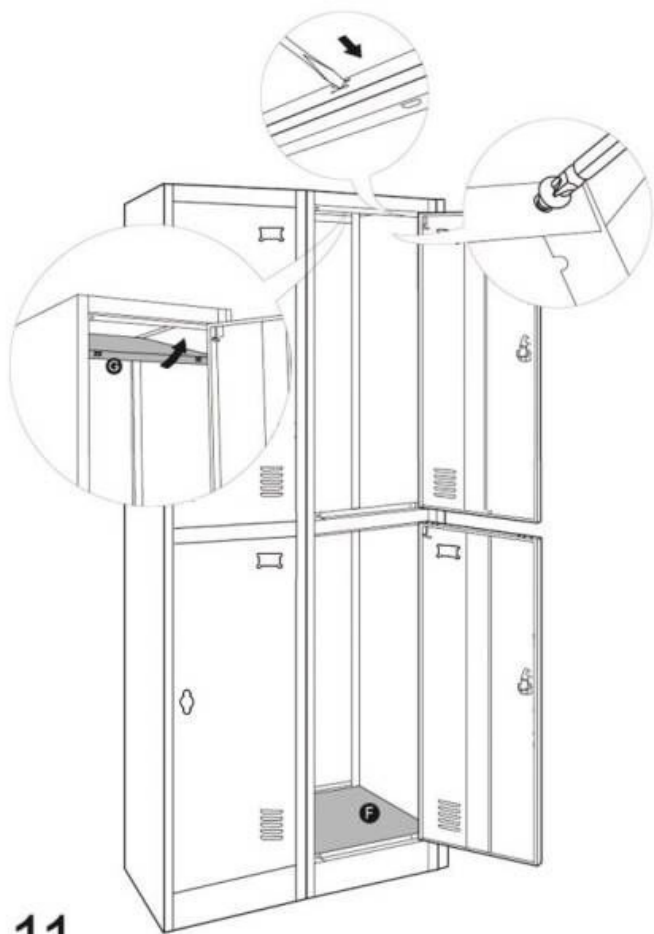

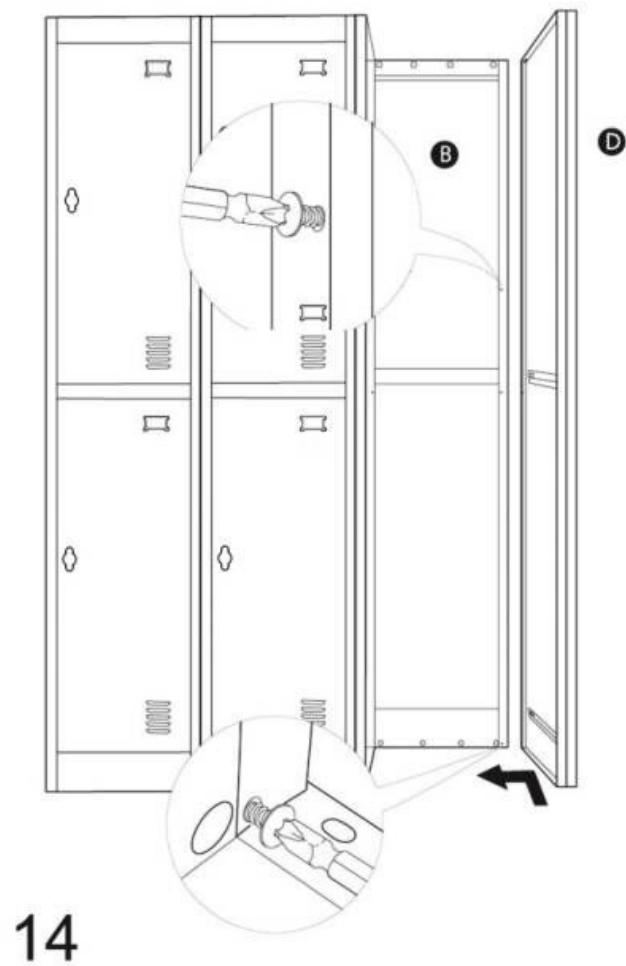
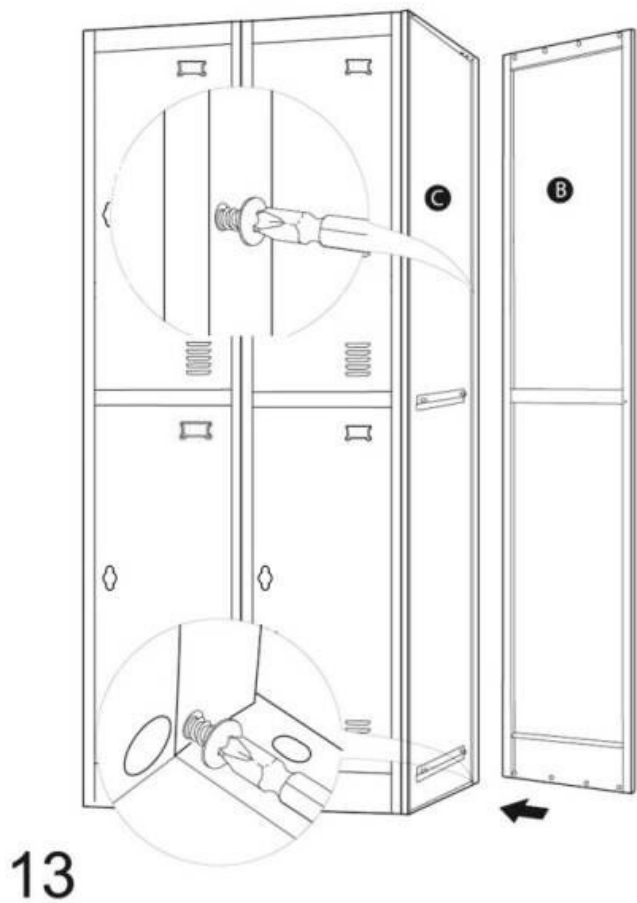

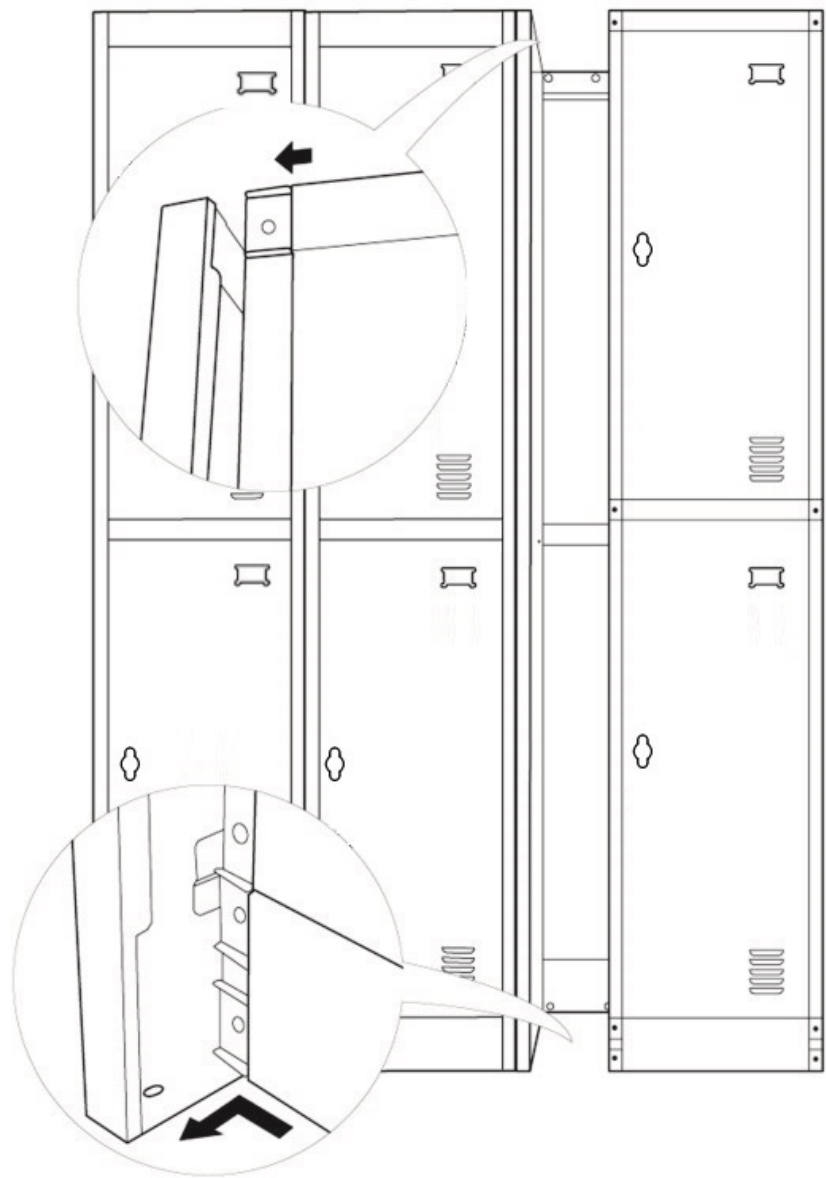

15

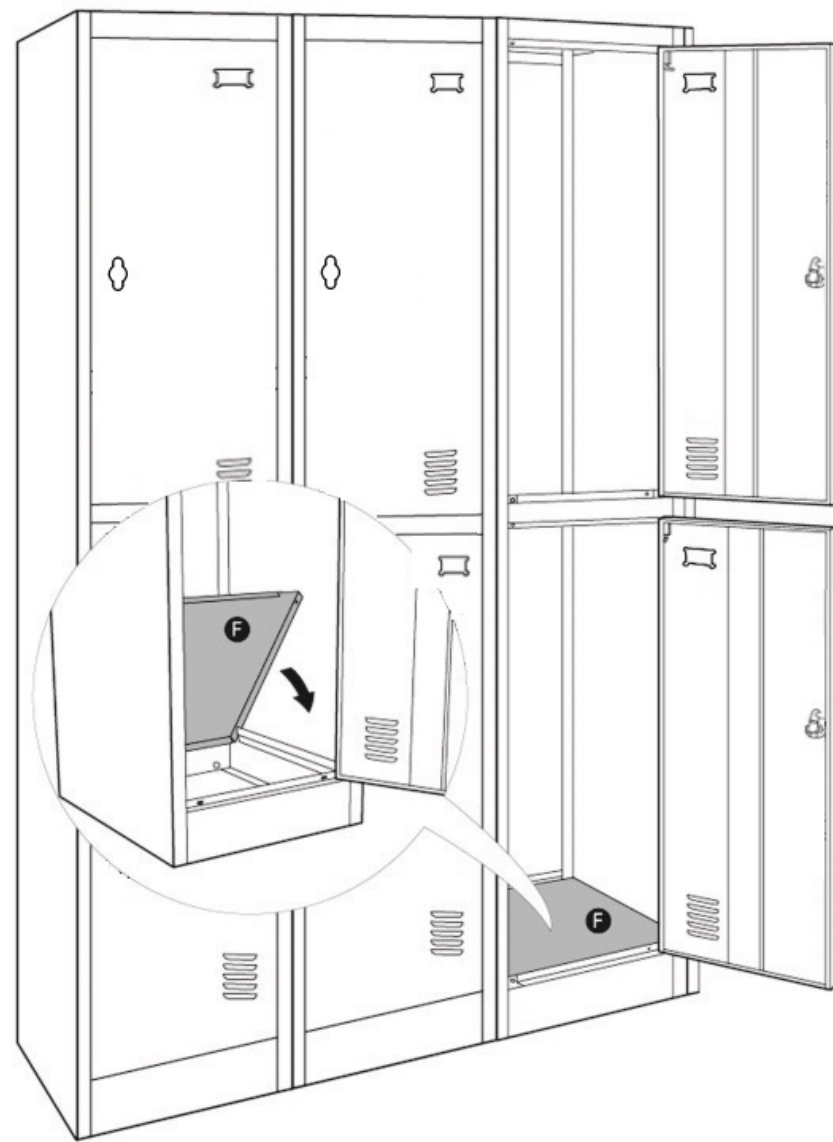

16

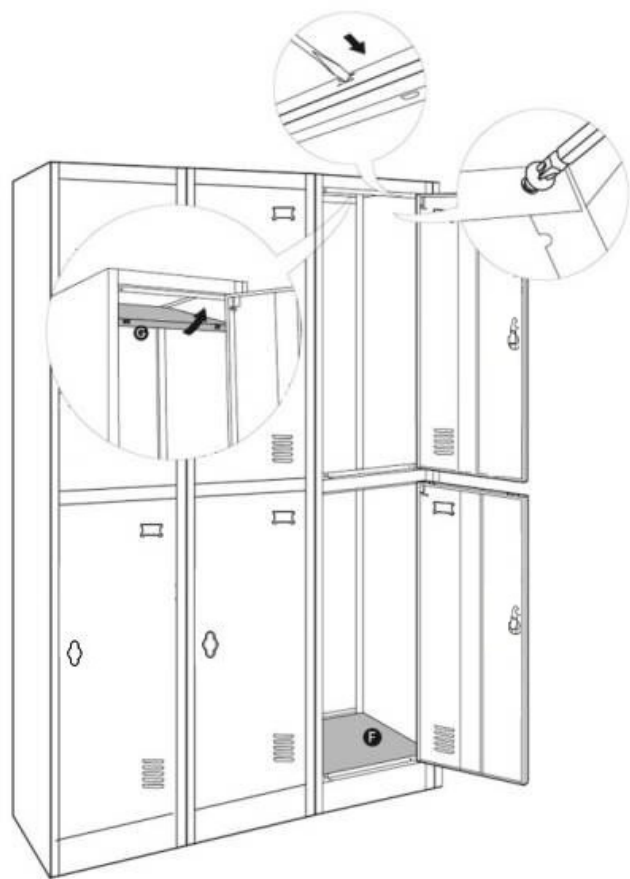

17

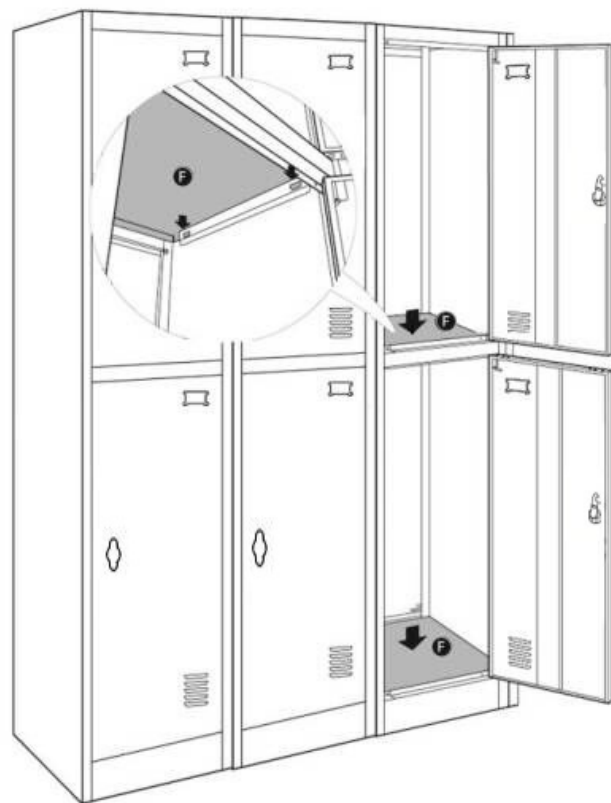

18